

Data sheet | Item number: 859-802

DC/DC Converter; 24 VDC input voltage; 10 VDC output voltage; 0.5 A output current

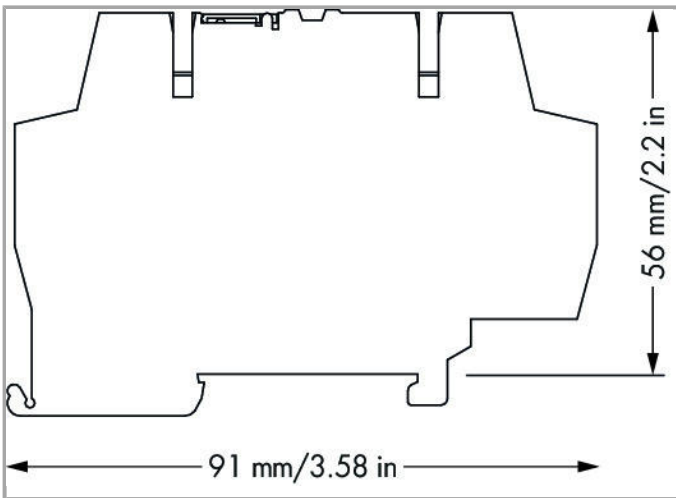

859-802

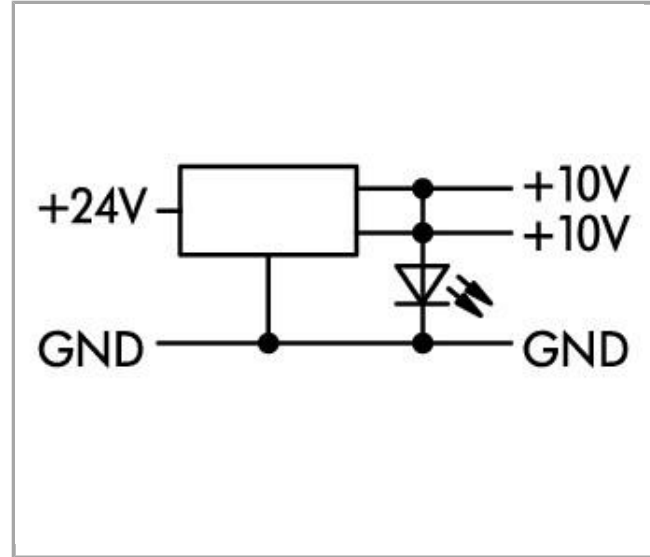
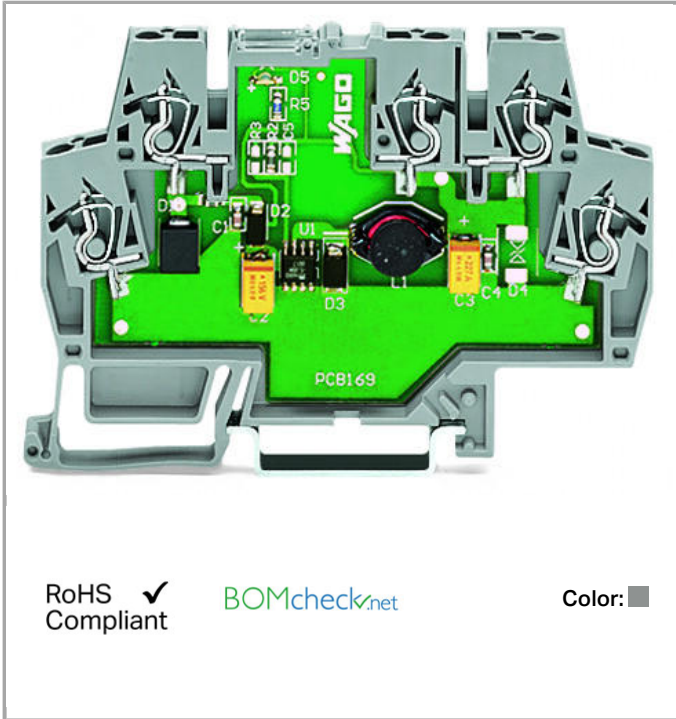

Data  
Technical Data

Input

Nominal input voltage $U_{i\text{nom}}$	DC 24 V
Input voltage range	DC 15 ... 30 V



Nominal mains frequency range	0 Hz
Mains failure hold-up time	≥ 0.5 ms

## Output

Nominal output voltage $U_{o\ nom}$	DC 10 V
Output voltage range	±2 %
Nominal output current $I_{o\ nom}$	0.5 A
Line regulation	≤ 0.5 %
Mains/load regulation	≤ 0.7 %
Residual ripple	≤ 20 mV
Switching frequency	20 kHz (nominal)
Overload behavior	Temporary without damage (short-circuit of the output for 1 minute)

## Signaling and communication

Signaling	1 x LED
-----------	---------

## Efficiency/Power losses:

Efficiency	85 %
------------	------

## Fuse protection:

Internal fuse	TVS diode
---------------	-----------

## Safety and protection:

Protection class	III
Protection class	IP20 (per EN 60529)
Reverse voltage protection	yes
Series connection	No

## Connection data

Number of jumper slots	2
Connection technology	CAGE CLAMP®
WAGO terminal	WAGO 859 Series
Solid conductor	0.08 ... 2.5 mm <sup>2</sup> / 28 ... 14 AWG
Fine-stranded conductor	0.08 ... 2.5 mm <sup>2</sup> / 28 ... 14 AWG
Strip length	5 ... 6 mm / 0.2 ... 0.24 inch

## Geometrical Data

Width	6 mm / 0.236 inch
-------	-------------------

Height from upper-edge of DIN-35 rail	56 mm / 2.205 inch
Depth	91 mm / 3.583 inch

### Mechanical data

Type of mounting	DIN-35 rail (EN 60715)
------------------	------------------------

### Material Data

Color	gray
Fire load	0MJ
Weight	41.1 g

### Environmental Requirements

Surrounding air (operating) temperature	-25 ... 55 °C
Pollution degree	2

### Standards and specifications

Conformity marking	1
--------------------	---

### Commercial data

Country of origin	US
GTIN	4050821083313
Customs Tariff No.	85044082900

### Approvals / Certificates

#### UL-Approvals

Logo	Approval	Additional Approval Text	Certificate name
	UL UL International Netherlands B.V. (ORDINARY LOCATIONS)	UL 508	E175199 Sec.4

### Compatible products

#### End plate



Item no.: 859-525  
End and intermediate plate; 1 mm thick

859-525

## tools



**Item no.: 210-720**  
Operating tool with partially insulated shaft; Type 2, blade (3.5 x 0.5) mm

210-720

## ferrule



**Item no.: 216-221**  
Ferrule; Sleeve for 0.5 mm<sup>2</sup> / 20 AWG; insulated; electro-tin plated

216-221



**Item no.: 216-222**  
Ferrule; Sleeve for 0.75 mm<sup>2</sup> / 18 AWG; insulated; electro-tin plated

216-222



**Item no.: 216-223**  
Ferrule; Sleeve for 1 mm<sup>2</sup> / AWG 18; insulated; electro-tin plated

216-223



**Item no.: 216-224**  
Ferrule; Sleeve for 1.5 mm<sup>2</sup> / AWG 16; insulated; electro-tin plated

216-224

**Item no.: 216-321**  
Ferrule; Sleeve for 0.25 mm<sup>2</sup> / AWG 24; insulated; electro-tin plated

216-321



**Item no.: 216-322**  
Ferrule; Sleeve for 0.34 mm<sup>2</sup> / 22 AWG; insulated; electro-tin plated

216-322

## Marking accessories



**Item no.: 2009-145**  
Mini-WSB Inline; for Smart Printer; on reel; stretchable 5 - 5.2 mm; plain; snap-on type

2009-145



**Item no.: 2009-145/000-002**  
Mini-WSB Inline; for Smart Printer; on reel; stretchable 5 - 5.2 mm; plain; snap-on type

/000-002

2009-145



**Item no.: 2009-145/000-005**  
Mini-WSB Inline; for Smart Printer; on reel; stretchable 5 - 5.2 mm; plain; snap-on type

/000-005

2009-145



**Item no.: 2009-145/000-006**  
Mini-WSB Inline; for Smart Printer; on reel; stretchable 5 - 5.2 mm; plain; snap-on type

/000-006

2009-145



**Item no.: 2009-145/000-007**  
Mini-WSB Inline; for Smart Printer; on reel; stretchable 5 - 5.2 mm; plain; snap-on type

/000-007

2009-145



**Item no.: 2009-145/000-012**  
Mini-WSB Inline; for Smart Printer; on reel; stretchable 5 - 5.2 mm; plain; snap-on type

/000-012

2009-145



**Item no.: 2009-145/000-023**  
Mini-WSB Inline; for smartPRINTER; on reel; stretchable 5 - 5.2 mm; plain; snap-on type

/000-023

2009-145



**Item no.: 2009-145/000-024**  
Mini-WSB Inline; for Smart Printer; on reel; stretchable 5 - 5.2 mm; plain; snap-on type















/000-024















2009-145



**Item no.: 210-110**  
Fiber-tip pen

210-110

	<b>Item no.: 248-501</b> Miniature WSB Quick marking system; plain; Marker width 5 mm; 10 strips with 10 markers per card		248-501
	<b>Item no.: 248-501/000-002</b> Mini-WSB marking card; as card; not stretchable; plain; snap-on type	/000-002	248-501
	<b>Item no.: 248-501/000-005</b> Mini-WSB marking card; as card; not stretchable; plain; snap-on type	/000-005	248-501
	<b>Item no.: 248-501/000-006</b> Mini-WSB marking card; as card; not stretchable; plain; snap-on type	/000-006	248-501
	<b>Item no.: 248-501/000-007</b> Mini-WSB marking card; as card; not stretchable; plain; snap-on type	/000-007	248-501
	<b>Item no.: 248-501/000-012</b> Mini-WSB marking card; as card; not stretchable; plain; snap-on type	/000-012	248-501
	<b>Item no.: 248-501/000-017</b> Mini-WSB marking card; as card; not stretchable; plain; snap-on type	/000-017	248-501
	<b>Item no.: 248-501/000-023</b> Mini-WSB marking card; as card; not stretchable; plain; snap-on type	/000-023	248-501
	<b>Item no.: 248-501/000-024</b> Mini-WSB marking card; as card; not stretchable; plain; snap-on type	/000-024	248-501
	<b>Item no.: 248-502</b> Mini-WSB marking card; as card; MARKED; 1 ... 10 (10x); not stretchable; Horizontal marking; snap-on type		248-502
	<b>Item no.: 248-502/000-024</b> Mini-WSB marking card; as card; MARKED; 1 ... 10 (10x); not stretchable; Horizontal marking; snap-on type	/000-024	248-502
	<b>Item no.: 248-503</b> Mini-WSB marking card; as card; MARKED; 11 ... 20 (10x); not stretchable; Horizontal marking; snap-on type		248-503
	<b>Item no.: 248-503/000-024</b> Mini-WSB marking card; as card; MARKED; 11 ... 20 (10x); not stretchable; Horizontal marking; snap-on type	/000-024	248-503
	<b>Item no.: 248-504/000-024</b> Mini-WSB marking card; as card; MARKED; 21 ... 30 (10x); not stretchable; Horizontal marking; snap-on type	/000-024	248-504
	<b>Item no.: 248-505/000-024</b> Mini-WSB marking card; as card; MARKED; 31 ... 40 (10x); not stretchable; Horizontal marking; snap-on type	/000-024	248-505
	<b>Item no.: 248-506</b>		

	Mini-WSB marking card; as card; MARKED; 41 ... 50 (10x); not stretchable; Horizontal marking; snap-on type		248-506
	<b>Item no.: 793-501</b> WMB marking card; as card; not stretchable; plain; snap-on type		793-501
	<b>Item no.: 793-501/000-002</b> WMB marking card; as card; not stretchable; plain; snap-on type	/000-002	793-501
	<b>Item no.: 793-501/000-005</b> WMB marking card; as card; not stretchable; plain; snap-on type	/000-005	793-501
	<b>Item no.: 793-501/000-006</b> WMB marking card; as card; not stretchable; plain; snap-on type	/000-006	793-501
	<b>Item no.: 793-501/000-007</b> WMB marking card; as card; not stretchable; plain; snap-on type	/000-007	793-501
	<b>Item no.: 793-501/000-012</b> WMB marking card; as card; not stretchable; plain; snap-on type	/000-012	793-501
	<b>Item no.: 793-501/000-017</b> WMB marking card; as card; not stretchable; plain; snap-on type	/000-017	793-501
	<b>Item no.: 793-501/000-023</b> WMB marking card; as card; not stretchable; plain; snap-on type	/000-023	793-501
	<b>Item no.: 793-501/000-024</b> WMB marking card; as card; not stretchable; plain; snap-on type	/000-024	793-501
	<b>Item no.: 793-5501</b> WMB marking card; as card; for terminal block width 5 - 17.5 mm; stretchable 5 - 5.2 mm; plain; snap-on type		793-5501
	<b>Item no.: 793-5501/000-002</b> WMB marking card; as card; for terminal block width 5 - 17.5 mm; stretchable 5 - 5.2 mm; plain; snap-on type	/000-002	793-5501
	<b>Item no.: 793-5501/000-005</b> WMB marking card; as card; stretchable 5 - 5.2 mm; plain; snap-on type	/000-005	793-5501
	<b>Item no.: 793-5501/000-006</b> WMB marking card; as card; stretchable 5 - 5.2 mm; plain; snap-on type	/000-006	793-5501
	<b>Item no.: 793-5501/000-007</b> WMB marking card; as card; stretchable 5 - 5.2 mm; plain; snap-on type	/000-007	793-5501



Item no.: 793-5501/000-012

WMB marking card; as card; stretchable 5 - 5.2 mm; plain; snap-on type

793-5501

/000-012



Item no.: 793-5501/000-017

WMB marking card; as card; stretchable 5 - 5.2 mm; plain; snap-on type

793-5501

/000-017



Item no.: 793-5501/000-023

WMB marking card; as card; stretchable 5 - 5.2 mm; plain; snap-on type

793-5501

/000-023



Item no.: 793-5501/000-024

WMB marking card; as card; stretchable 5 - 5.2 mm; plain; snap-on type

793-5501

/000-024

## Downloads

### Documentation

#### Bid Text

859-802	Jan 14, 2016	doc	Download
Stromversorgung EPSITRON		26.6 kB	

#### Instruction Leaflet

DC/DC-Wandler		pdf	Download
		68.8 kB	

#### Additional Information

Disposal; Electrical and electronic equipment, Packaging	V 1.0.0	pdf	Download
		265.8 kB	

## CAD/CAE - Smart Data

### CAD data

3D Download 859-802		URL	Download
---------------------	--	-----	----------

Subject to changes.